

Section A

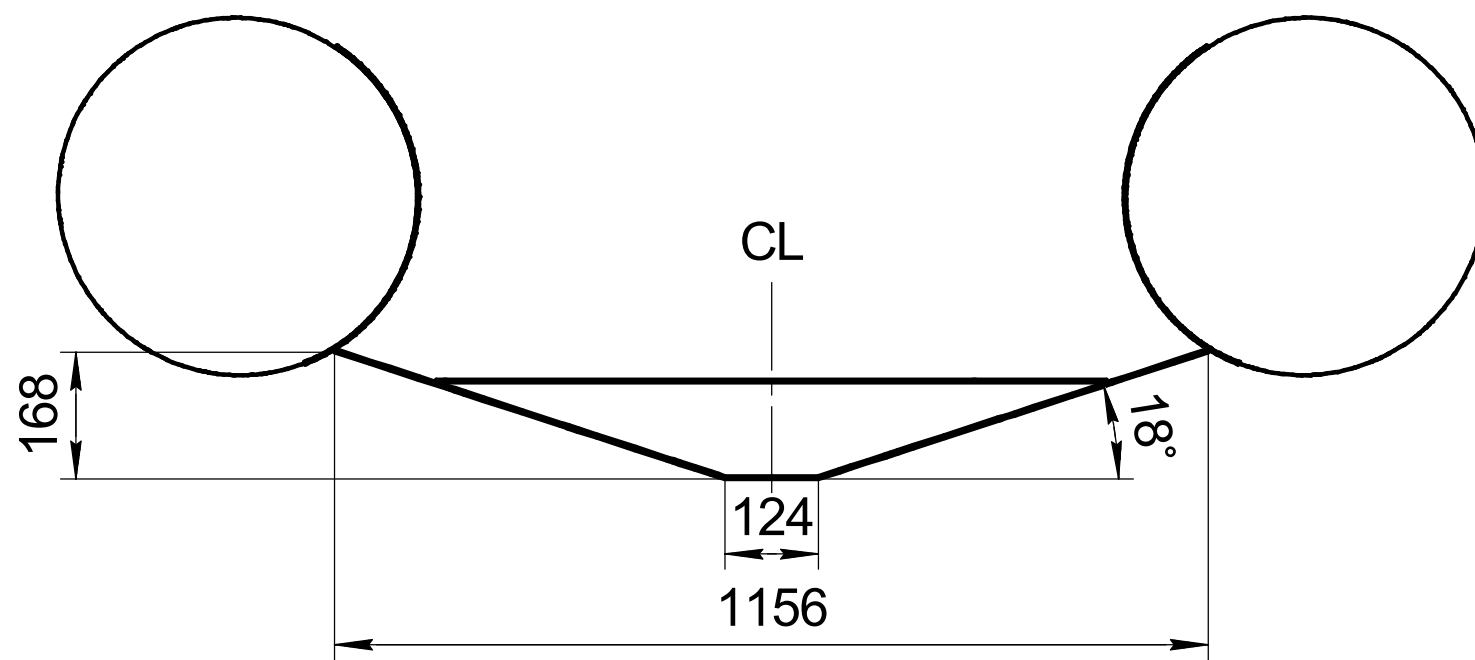

Section B

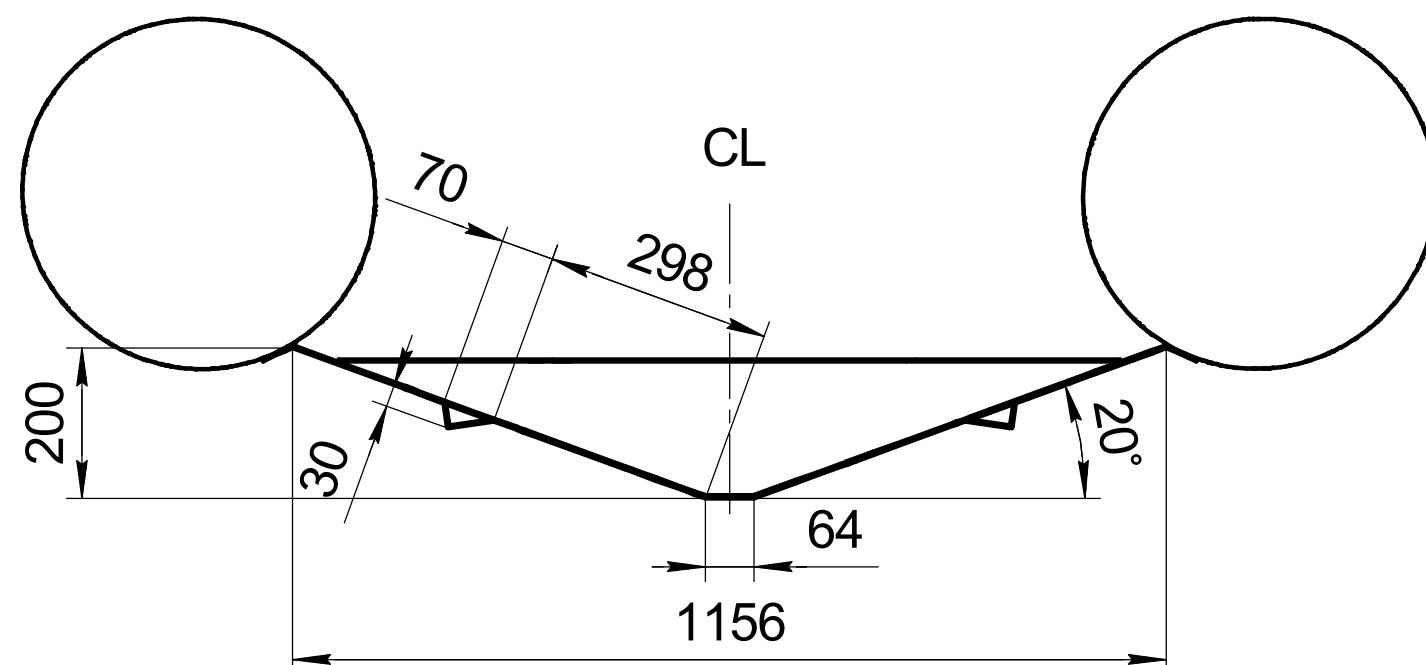

Section C

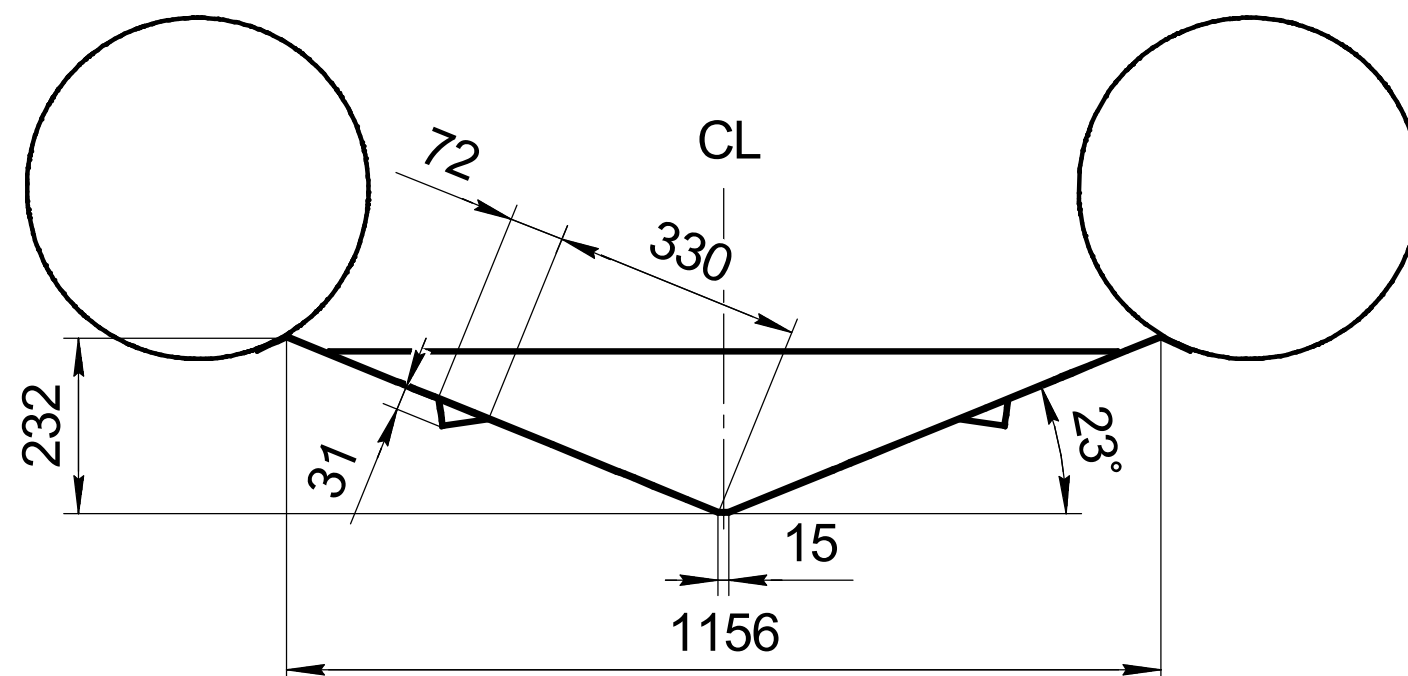

	NAME	DATE	ITEM No:
DRAWN			
CHECKED			TITLE:
ENG APPR.			GALA Atlantis A400L Hull sections for chocks design
MFG APPR.			
Q.A.			
PROPRIETARY AND CONFIDENTIAL THE INFORMATION CONTAINED IN THIS DRAWING IS THE SOLE PROPERTY OF CALIBR PROFIT LLC			
SIZE	DWG. NO.	REV	
SCALE: 1:10	WEIGHT:	SHEET 1 OF 1	